

Thank you for your purchase of our new SS3 Type SD Foglight Kit. CAD-designed to use existing mounting points, this kit is compatible with the 2011-2016 Ford F-250/F-350. Basic installation instructions are included below.

Please contact us if you have any questions.

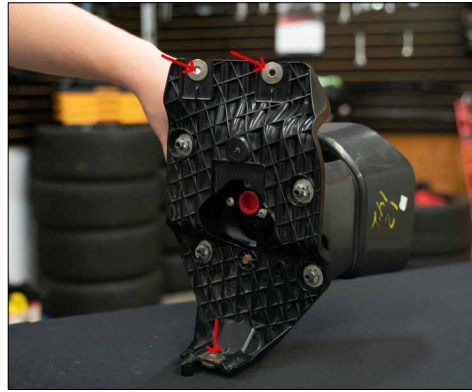

1. Remove the metal brace to gain access to the foglight bracket assembly. Use a 13mm socket and ratchet to remove the four bolts shown above.



2. With the metal brace removed you can remove the entire foglight bracket assembly by removing the three 8mm bolts shown above.

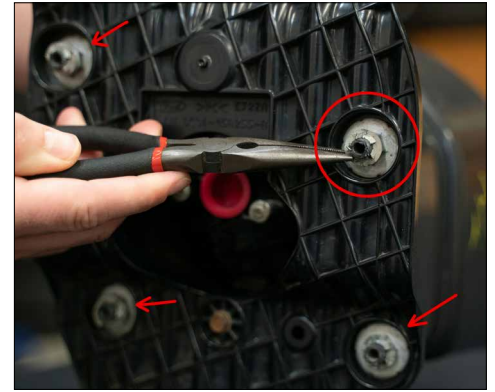

3. Set the foglight bracket assembly on a table. Remove the four metal retaining washers using a pick or flathead screw driver. Then remove the four 13mm nuts that secure the front bezel to the foglight bracket.

These parts will be reused.



4. Remove the adjustment aiming screw using an 8mm socket.

The adjustment screw, spring, and plastic clip will be reused.



5. Remove the two plastic push rivets shown above that secure the OEM lamp onto the foglight bracket using a trim removal tool (or flat head screw driver).

These will be reused as well.

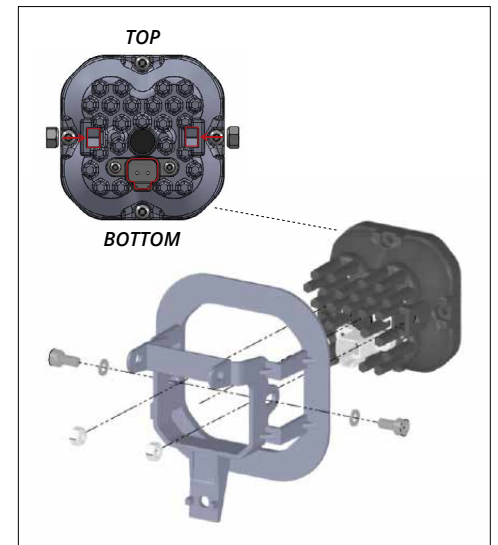

6. Using the included hardware, attach the Type SD bracket to the pod. See the diagram above and make sure the bracket is in the correct orientation. Tighten these bolts down all the way.

NOTE: The 3rd mounting point will be used for aiming.

See back for further instructions.

2015 Ford F-350
SS3 Type SD Foglight Kit

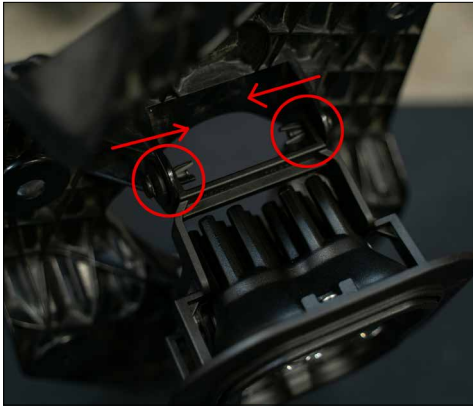

7. Install the Type SD bracket onto the factory foglight bracket, by reinstalling the plastic push rivets.

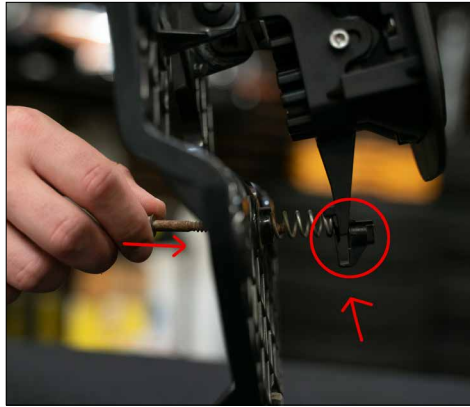

8. Reinstall the adjustment screw, spring, and plastic clip to the bottom of the bracket.

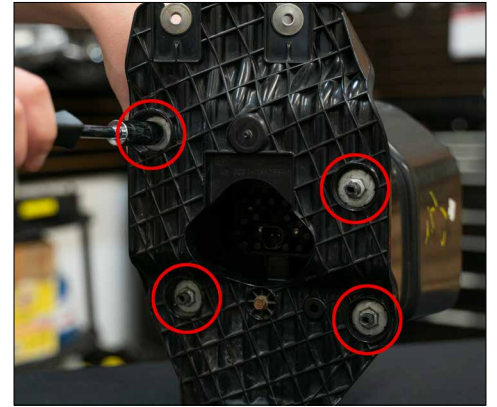

9. Reattach the front bezel using the four 13mm nuts. **Do not over tighten.**

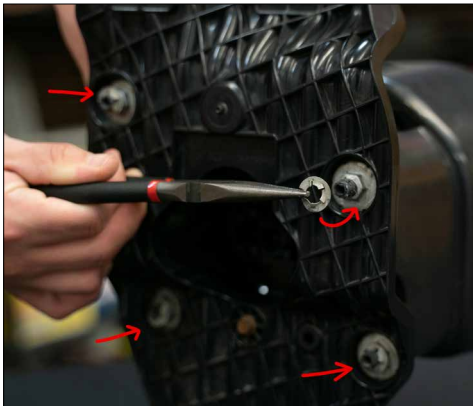

10. Reattach the metal retaining washers.

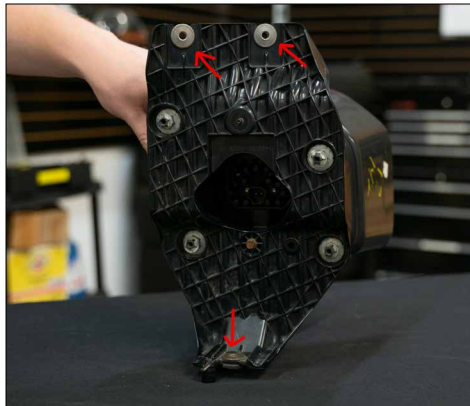

11. Reinstall the entire foglight bracket back onto the vehicle using the three 8mm bolts. Use the included wire adapters to connect the pod to the vehicle wiring harness. Test function. If the light does not turn on, try flipping the connector 180°.

Adjust and aim the fog light according to your local and state laws using the adjustment screw. In general, fog lamps should be angled slightly downwards to illuminate the area directly in front of the vehicle.



12. Finish the installation by reinstalling the metal brace using the four 13mm bolts removed in Step 1.

Repeat on other side to complete installation.

Please contact **Diode Dynamics** should you have any questions about the installation or wiring process, at **314-205-3033** (9a-5p CST) or **contact@diodedynamics.com**.

This installation guide is for the following SKUs:

DD6533 Worklight SS3 Sport Type SD Kit White Driving
DD6534 Worklight SS3 Sport Type SD Kit White Fog

DD6535 Worklight SS3 Sport Type SD Kit Yellow Fog
DD6536 Worklight SS3 Pro Type SD Kit White Driving

DD6357 Worklight SS3 Pro Type SD Kit White Fog
DD6358 Worklight SS3 Pro Type SD Kit Yellow Fog